

**DUAL LOW DROP HIGH POWER
OPERATIONAL AMPLIFIER**

ADVANCE DATA

- HIGH OUTPUT CURRENT
- VERY LOW SATURATION VOLTAGE
- LOW VOLTAGE OPERATION
- LOW INPUT OFFSET VOLTAGE
- GND COMPATIBLE INPUTS
- ST-BY FUNCTION (LOW CONSUMPTION)
- HIGH APPLICATION FLEXIBILITY

PROTECTIONS:

- VERY INDUCTIVE LOADS
- OVERRATING CHIP TEMPERATURE
- LOAD DUMP VOLTAGE
- FORTUITOUS OPEN GROUND
- ESD

DESCRIPTION

The L2750 is a new technology class AB dual power operational amplifier assembled in Multiwatt 11 package.

Thanks to the fully complementary PNP/NPN output configuration the L2750 can deliver a rail-to-

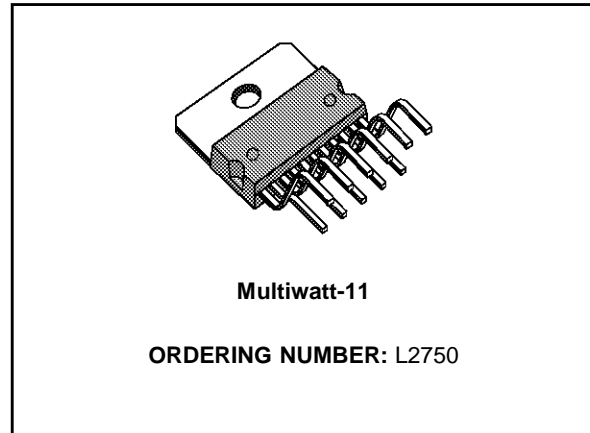

rail output voltage swing even at the highest current.

Additional feature is the very low current Stand-By function.

The high application flexibility of the L2750 makes the device suitable for either motor driving/control and audio applications purposes.

BLOCK DIAGRAM

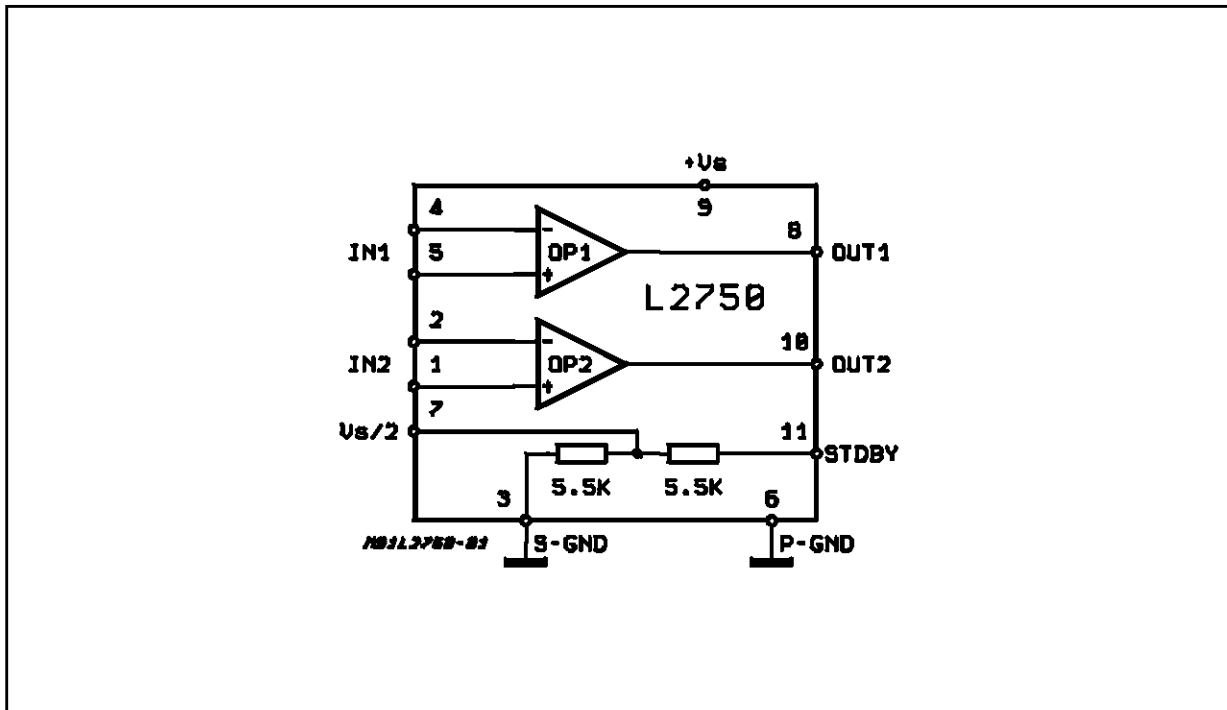

L2750

PIN CONNECTION (Top view)

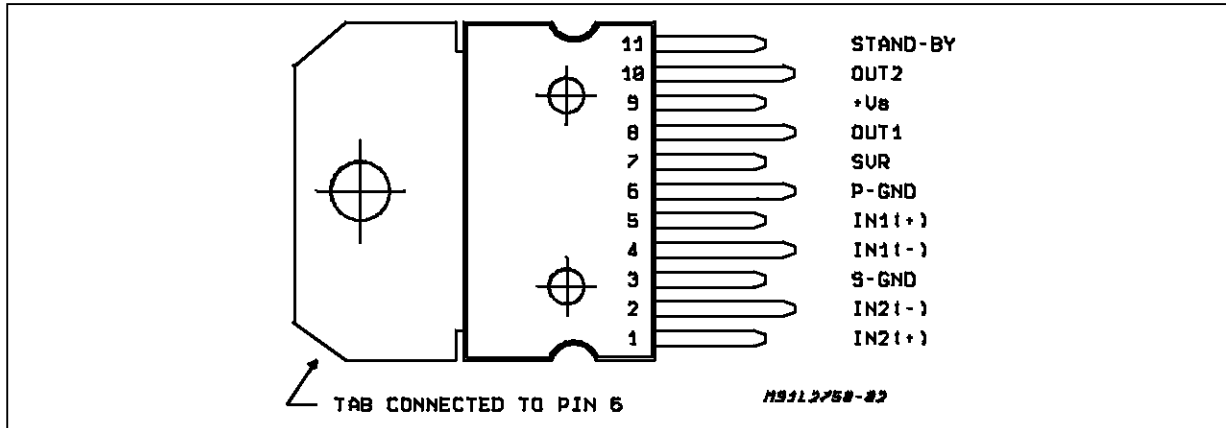

ABSOLUTE MAXIMUM RATINGS

Symbol	Parameter	Value	Unit
$V_{S\ op}$	Operating Supply Voltage	18	V
$V_{S\ max}$	Supply Voltage	28	V
V_{PEAK}	Peak Supply Voltage (t = 50ms)	40	V
V_i	Input Voltage	$V_{S\ op}$	V
V_i	Differential Input Voltage	$V_{S\ op}$	V
I_o	Output Peak Current (non rep. t = 100 μ s)	5	A
I_o	Output Peak Current (rep. f > 10Hz)	4	A
P_{tot}	Power Dissipation $T_{CASE} = 85^\circ\text{C}$	36	W
T_{stg}, T_j	Storage and Junction Temperature	-40 to 150	$^\circ\text{C}$

THERMAL DATA

Symbol	Description	Value	Unit
$R_{th\ j-case}$	Thermal Resistance Junction-case	Max 1.8	$^\circ\text{C/W}$

ELECTRICAL CHARACTERISTICS (Refer to the operational amplifier with $G_V = 24\text{dB}$; $V_S = 14.4\text{V}$; $T_{amb} = 25^\circ\text{C}$, unless otherwise specified)

Symbol	Parameter	Test Condition	Min.	Typ.	Max.	Unit
V_S	Supply Voltage		4		18	V
I_d	Total Quiescent Drain Current			30	50	mA
V_{OS}	Input Offset Voltage				5	mV
I_{SB}	ST-BY Current Consumption				50	μA
I_S	Input Bias Current				0.5	μA
I_{OS}	Input Offset Current				50	nA
V_{DROP}	Output Voltage Drop (High)	$I_o = 0.5\text{A}$ $I_o = 3\text{A}$		0.25 1.1	0.5 2.5	V V
	Output Voltage Drop (Low)	$I_o = 0.5\text{A}$ $I_o = 3\text{A}$		0.25 1	0.5 2	V V
SR	Slew Rate			4		V/ μs
B	Gain Bandwidth Prod			10		MHz
G_V	Open Loop Voltage Gain	f = 1KHz		85		dB
R_{IN}	Input Resistance			150		M Ω
E_{IN}	Input Noise Voltage	$R_s = 0$ to 10K Ω f = 22Hz to 22KHz		3		μV
CMRR	Common Mode Rejection Ratio		75	90		dB

ELECTRICAL CHARACTERISTICS (continued)

Symbol	Parameter	Test Condition	Min.	Typ.	Max.	Unit
SVR	Supply Voltage Rejection	$R_s = 0$ $f = 100\text{Hz}$	75	90		dB
C_T	Crosstalk	$f = 1\text{KHz to } 10\text{KHz}$		80		dB

APPLICATION SUGGESTION

The high flexibility makes the L2750 suitable for a wide range of applications.

Motor Controller

The device can be utilized as a motor controller. Fig.1 represents a bidirectional DC motor control suitable for logic driving. In these kinds of application it is possible to take advantage of the high current capability of the L2750 for driving several types of low impedance motors in a broad range of applications. Moreover the low drop allows high start up currents even at lowest supply voltage.

Audio Applications

Another typical utilization of the L2750 concerns the audio field, as follows:

- 1) DRIVER FOR BOOSTER : The remarkably low distortion and noise makes the device proper to be used as high quality driver for main amplifiers (i.e. car radio boosters). An example is shown by Fig. 5, where the gain is set to 24 dB (see also the relevant characteristics).
- 2) CAR RADIO BOOSTER WITH DIFFERENTIAL INPUT : Fig. 10 shows an example of car radio booster, with a gain of 30 dB, that is specially recommended for active loudspeakers. Among its main feature is the differential input and subsequent high noise suppression. The typical output power delivered into a 4Ω load is 24W ($V_s = 14.4\text{V}$; $d = 10\%$), as shown by the characteristics enclosed.

Figure 2: Low Drop Voltage vs. Output Current

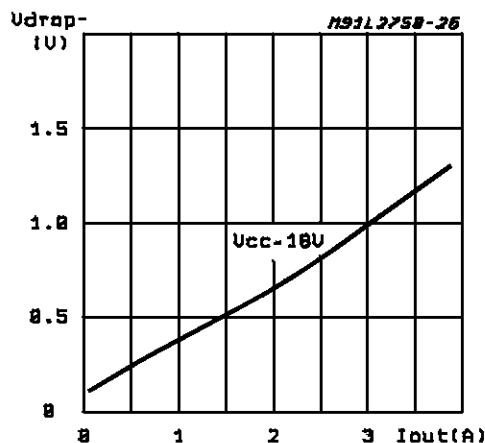

Figure 3: High Drop Voltage vs. Output Current

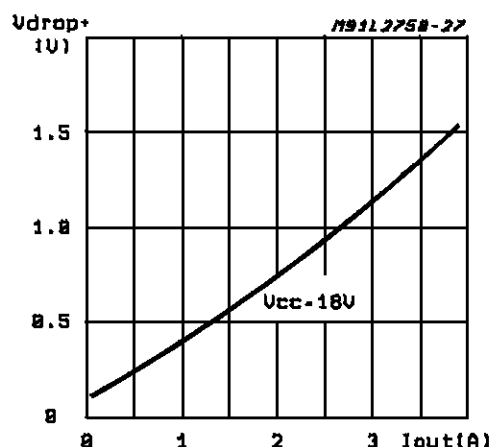

Figure 4: Open Loop Gain vs. Phase Response

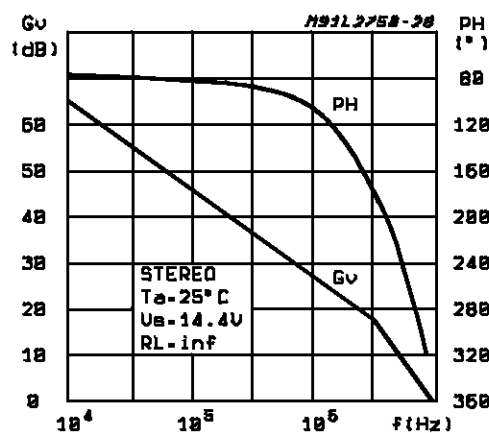

Figure 1

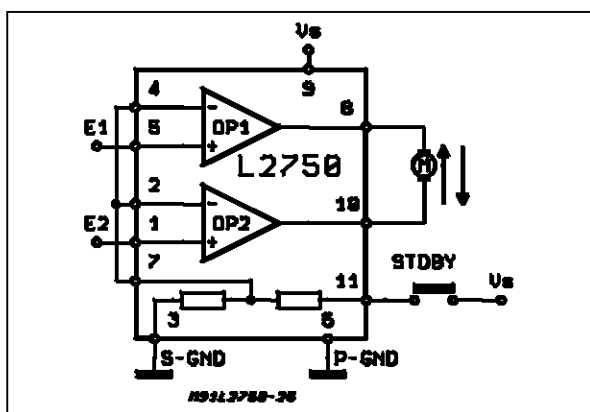

Figure 5: Stereo Audio Amplifier Application Circuit

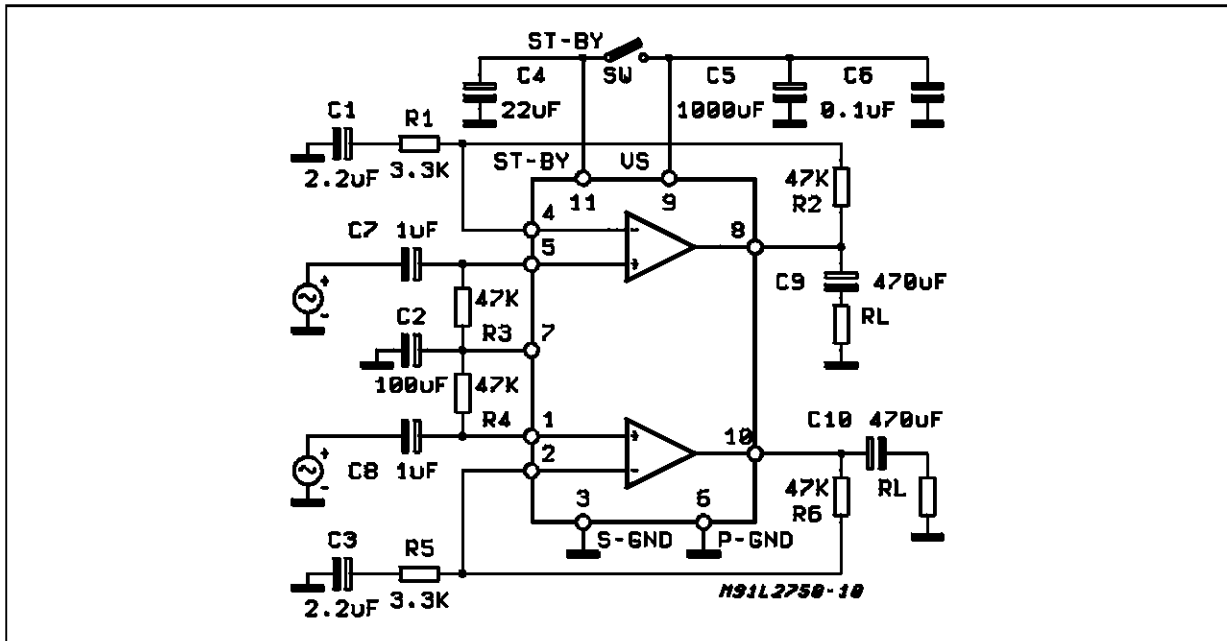
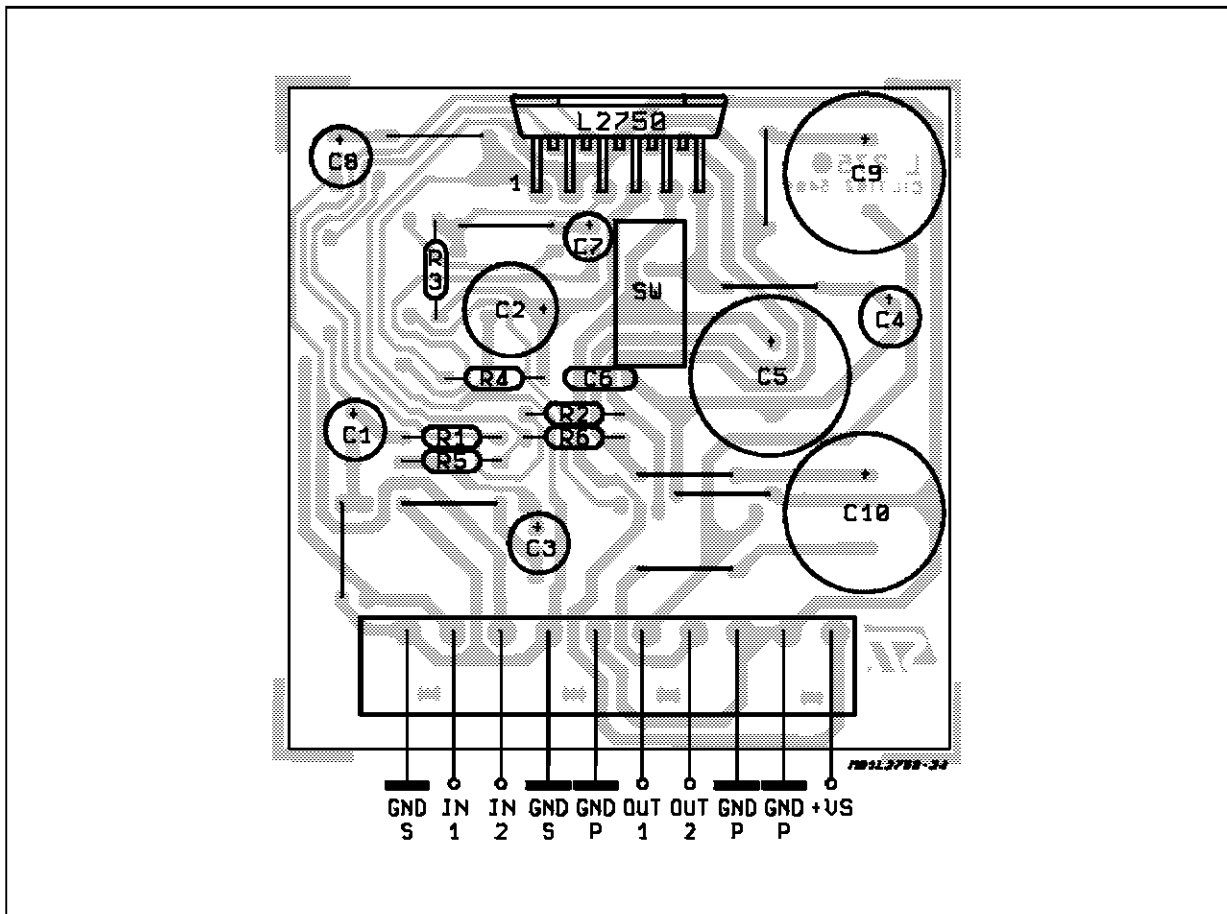

Figure 6: P.C. Board and Components Layout of the Circuit of Figure 5 (1:1 scale)



AUDIO STEREO APPLICATION CIRCUIT OF FIGURE 5

Figure 7: Quiescent Drain Current vs. Supply Voltage

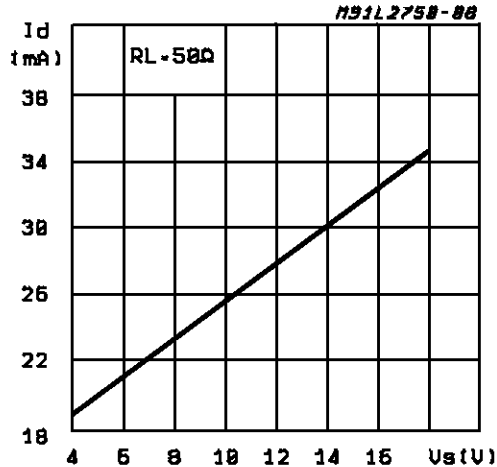

Figure 8: Distortion vs. Output Voltage

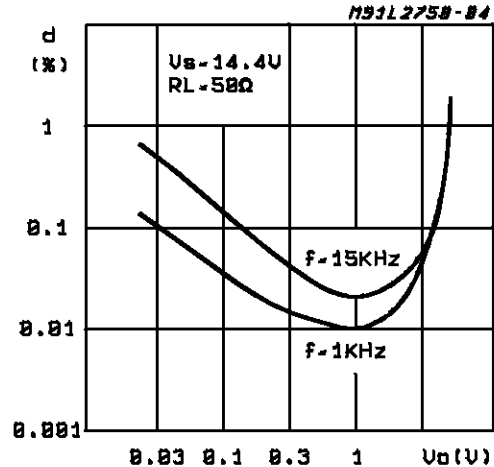

Figure 9: Distortion vs. Frequency

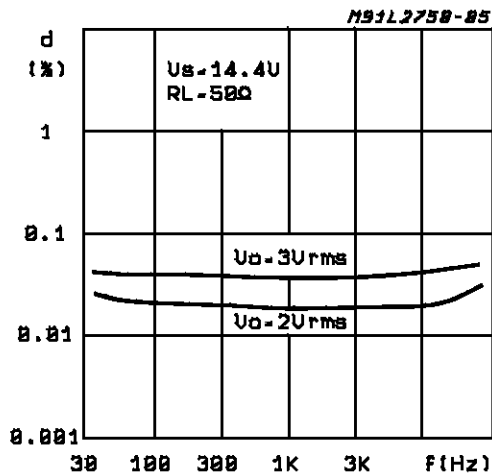

Figure 10: Cross-Talk vs Frequency

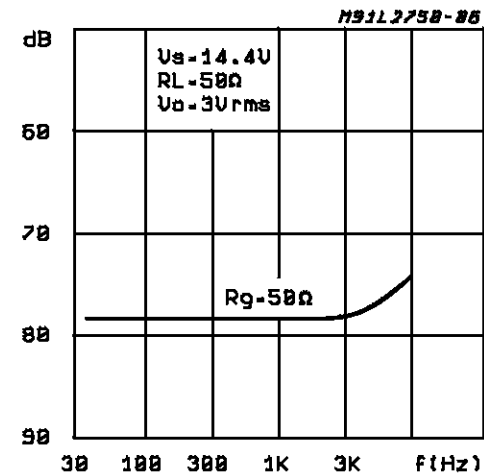

Figure 11: Supply Voltage Rejection vs. Frequency

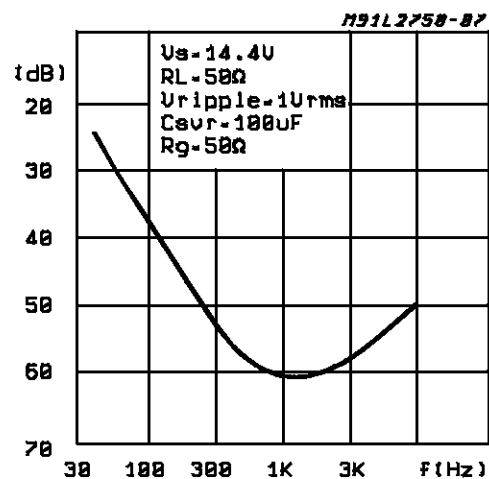

Figure 12: E_N Input vs. R_g

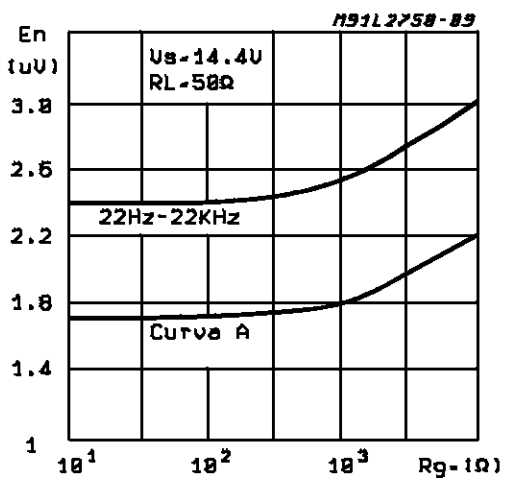

Figure 13: Bridge Power Amplifier with Balanced Input Application Circuit

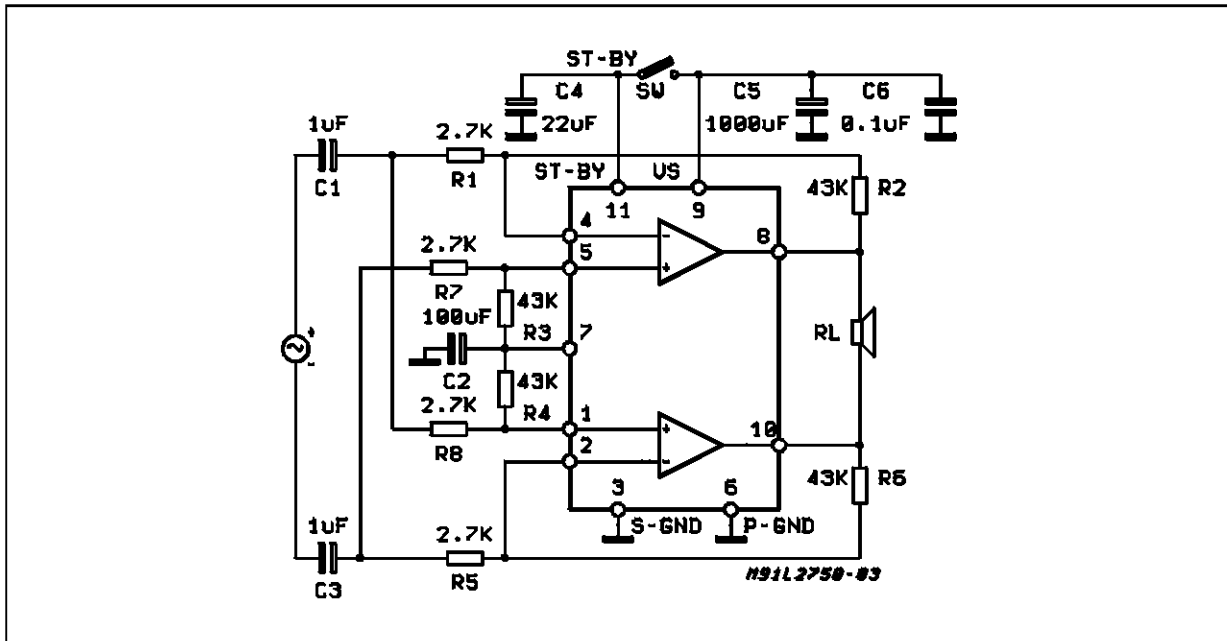
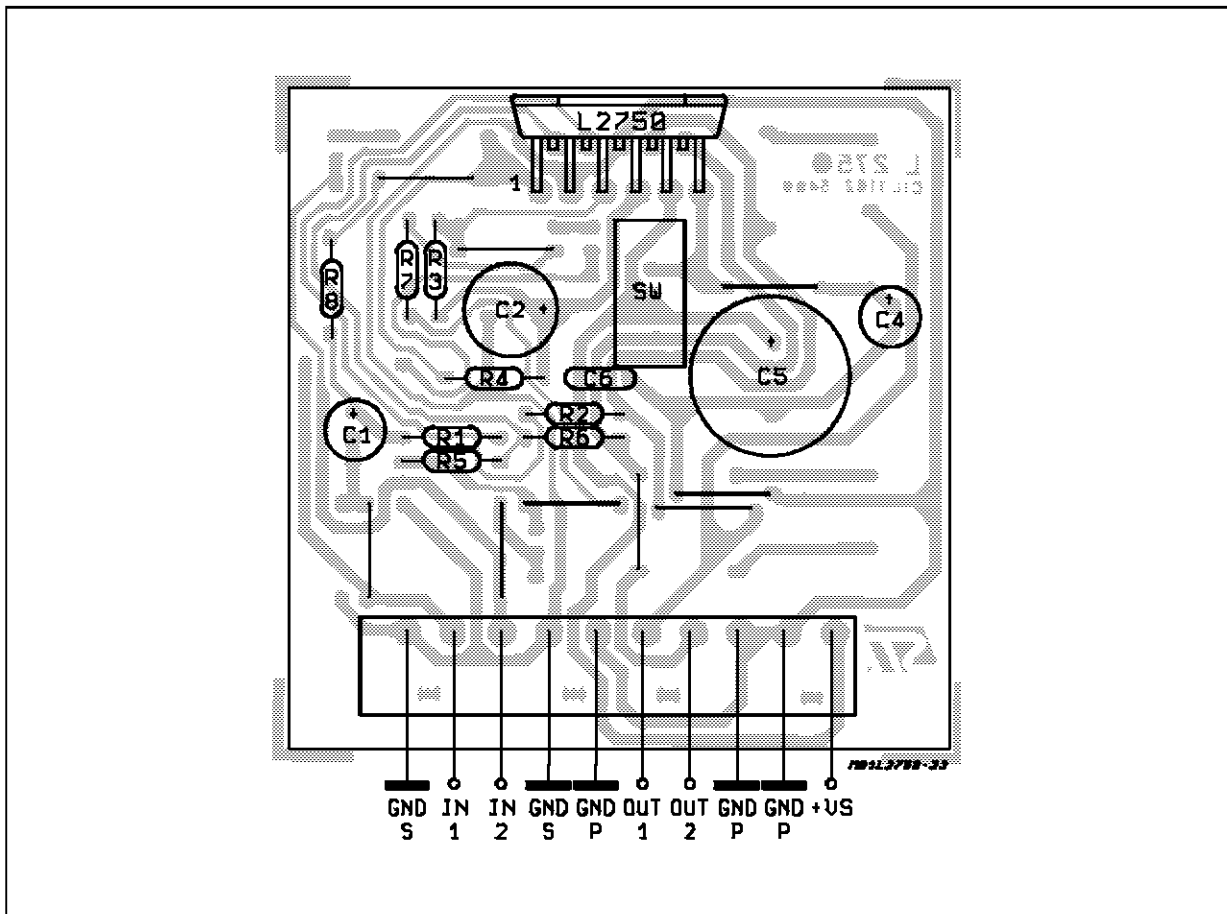

Figure 14: P.C. Board and Component Layout of the Circuit of Figure 13 (1:1 scale)



BRIDGE AUDIO APPLICATION CIRCUIT OF FIGURE 13

Figure 15: Quiescent Drain Current vs. Supply Voltage

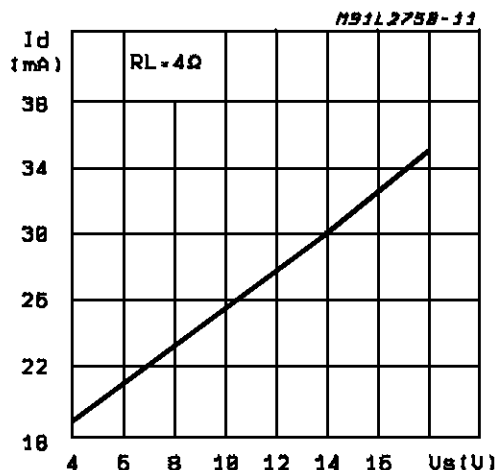

Figure 16: Noise vs. R_s

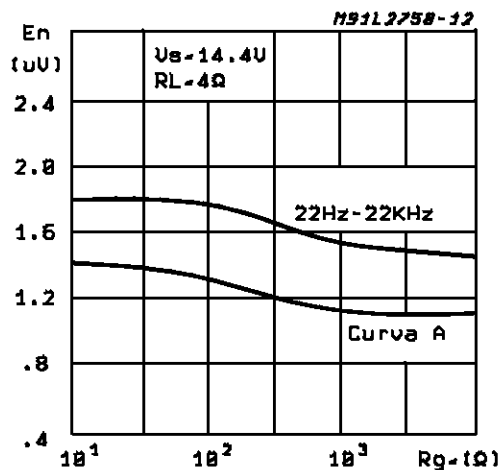

Figure 17: Output Power vs. Supply Voltage

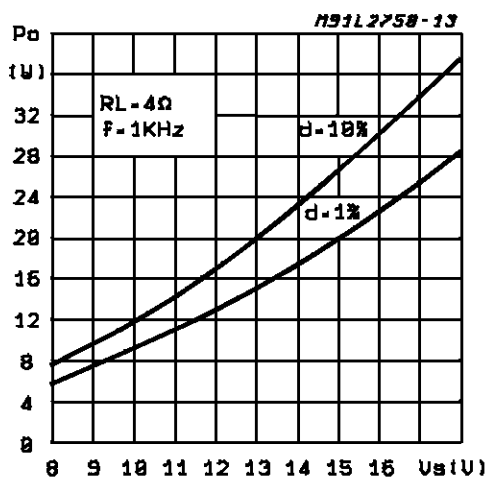

Figure 18: Output Power vs Supply Voltage

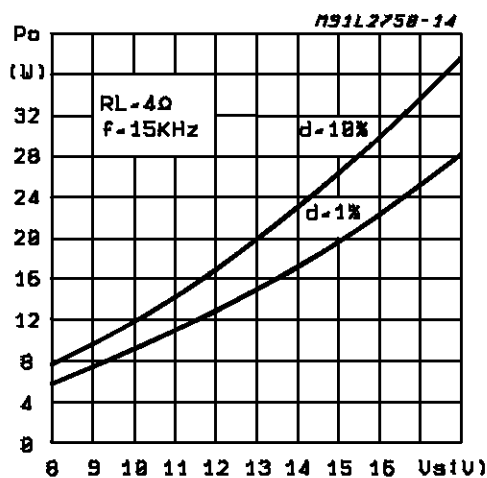

Figure 19: Distortion vs. Output Power

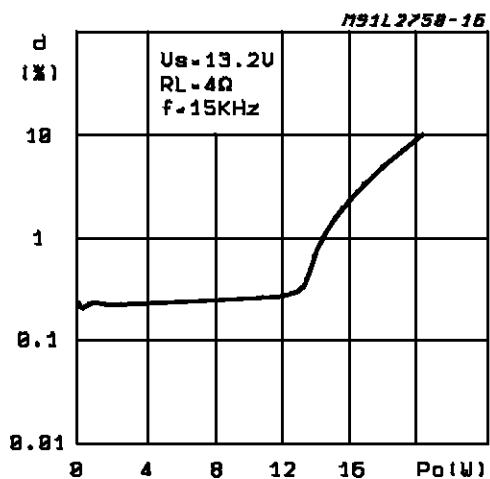

Figure 20: Distortion vs. Output Power

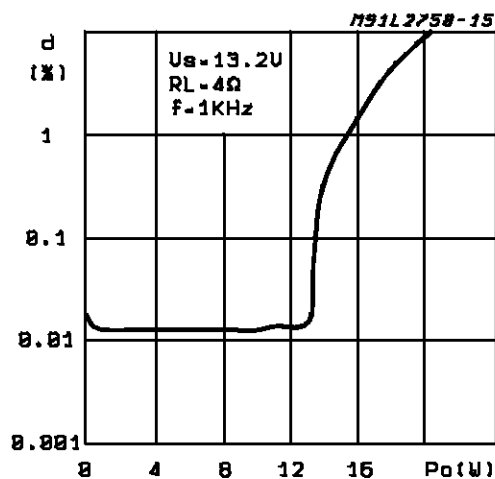

Figure 21: Distortion vs. Output Power

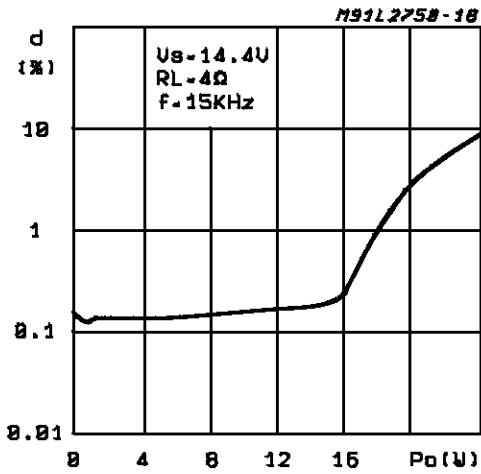

Figure 22: Distortion vs. Output Power

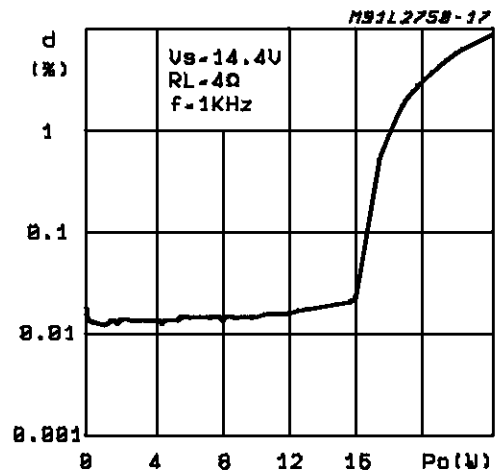

Figure 23: Distortion vs. Frequency

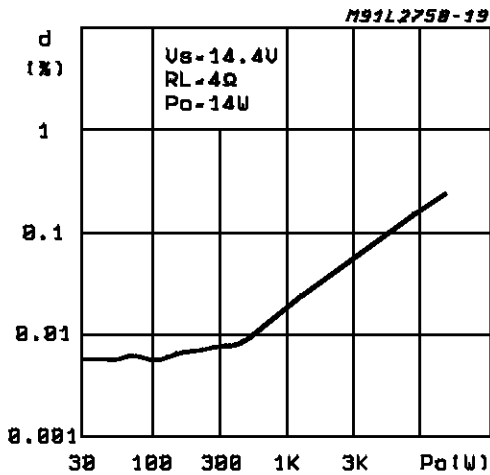

Figure 24: Supply Voltage Rejection vs. Frequency

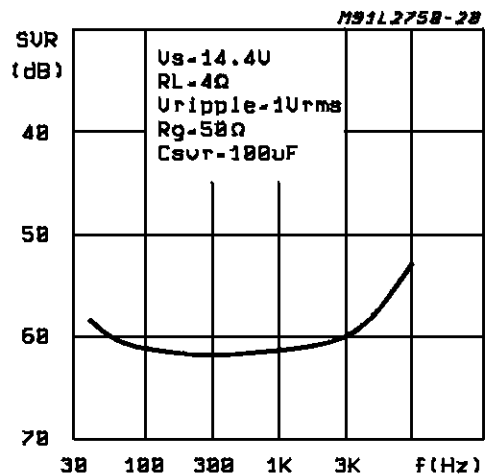

Figure 25: Total Power Dissipation and Efficiency vs. Output Power

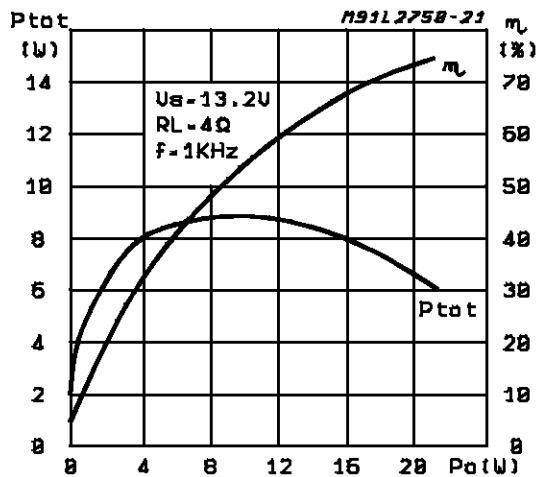
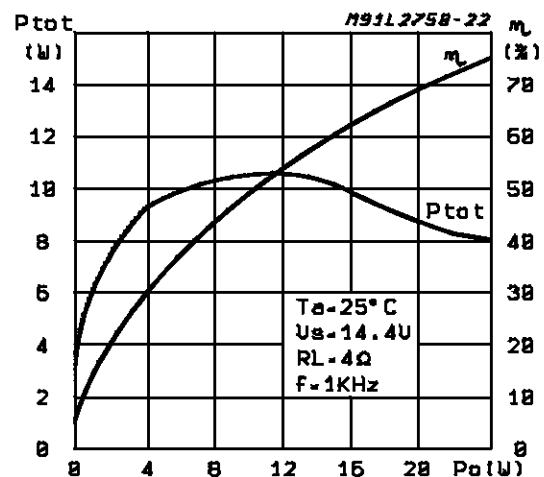
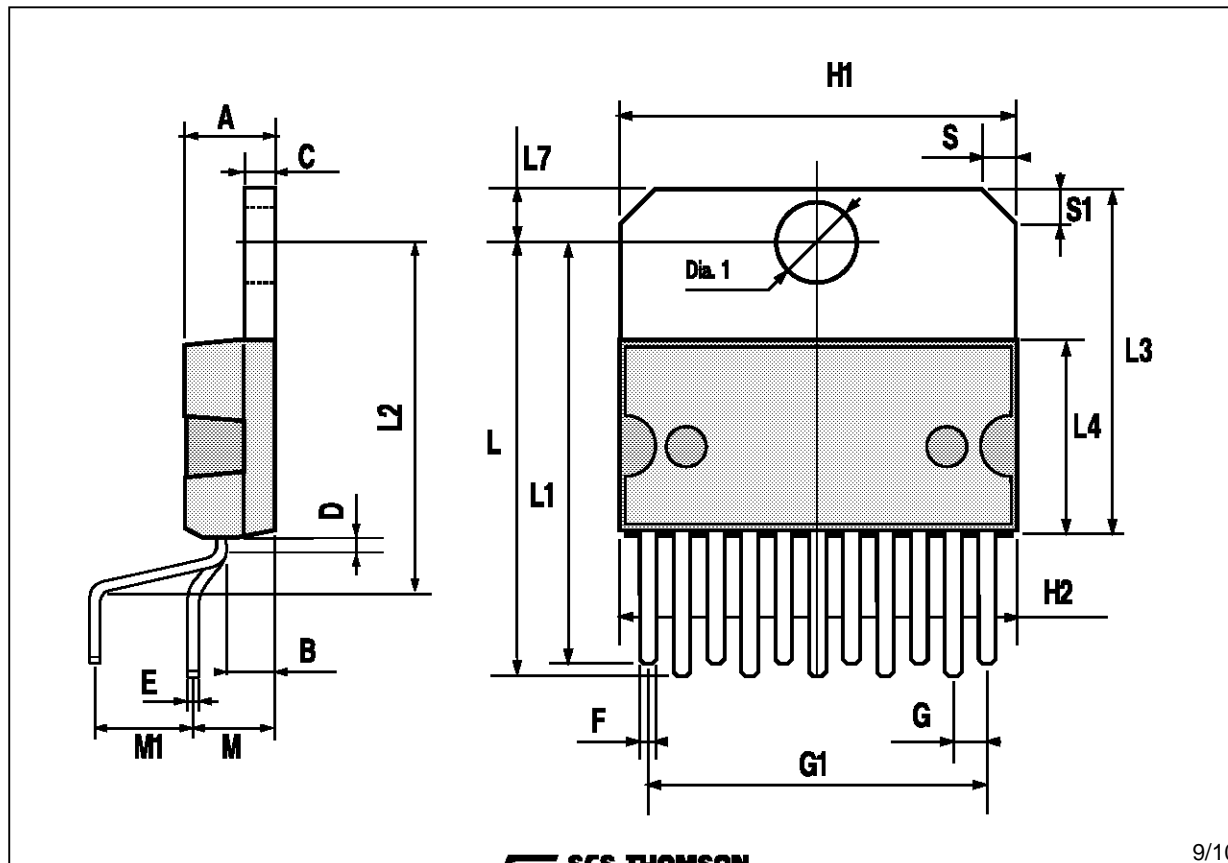

Figure 26: Total Power Dissipation and Efficiency vs. Output Power



MULTIWATT11 PACKAGE MECHANICAL DATA

DIM.	mm			inch		
	MIN.	TYP.	MAX.	MIN.	TYP.	MAX.
A			5			0.197
B			2.65			0.104
C			1.6			0.063
D		1			0.039	
E	0.49		0.55	0.019		0.022
F	0.88		0.95	0.035		0.037
G	1.57	1.7	1.83	0.062	0.067	0.072
G1	16.87	17	17.13	0.664	0.669	0.674
H1	19.6			0.772		
H2			20.2			0.795
L	21.5		22.3	0.846		0.878
L1	21.4		22.2	0.843		0.874
L2	17.4		18.1	0.685		0.713
L3	17.25	17.5	17.75	0.679	0.689	0.699
L4	10.3	10.7	10.9	0.406	0.421	0.429
L7	2.65		2.9	0.104		0.114
M	4.1	4.3	4.5	0.161	0.169	0.177
M1	4.88	5.08	5.3	0.192	0.200	0.209
S	1.9		2.6	0.075		0.102
S1	1.9		2.6	0.075		0.102
Dia1	3.65		3.85	0.144		0.152



Information furnished is believed to be accurate and reliable. However, SGS-THOMSON Microelectronics assumes no responsibility for the consequences of use of such information nor for any infringement of patents or other rights of third parties which may result from its use. No license is granted by implication or otherwise under any patent or patent rights of SGS-THOMSON Microelectronics. Specifications mentioned in this publication are subject to change without notice. This publication supersedes and replaces all information previously supplied. SGS-THOMSON Microelectronics products are not authorized for use as critical components in life support devices or systems without express written approval of SGS-THOMSON Microelectronics.

© 1994 SGS-THOMSON Microelectronics - All Rights Reserved

SGS-THOMSON Microelectronics GROUP OF COMPANIES
Australia - Brazil - France - Germany - Hong Kong - Italy - Japan - Korea - Malaysia - Malta - Morocco - The Netherlands - Singapore -
Spain - Sweden - Switzerland - Taiwan - Thailand - United Kingdom - U.S.A.